

Locomotive

1 x2 x2

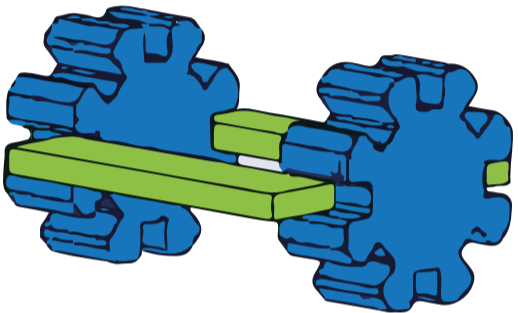

2 x2 x2

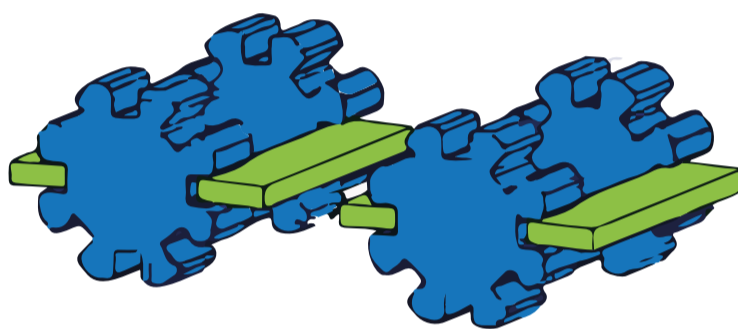

3 x2 x2

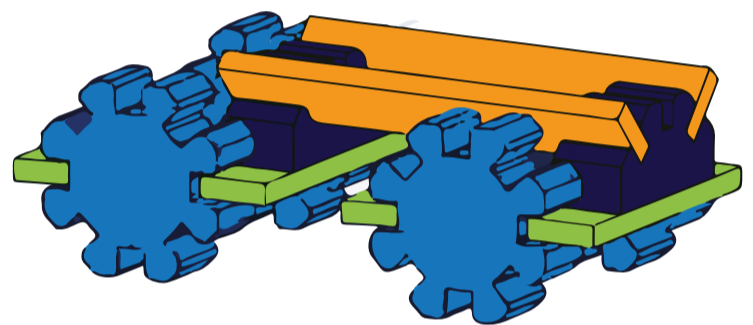

4 x3

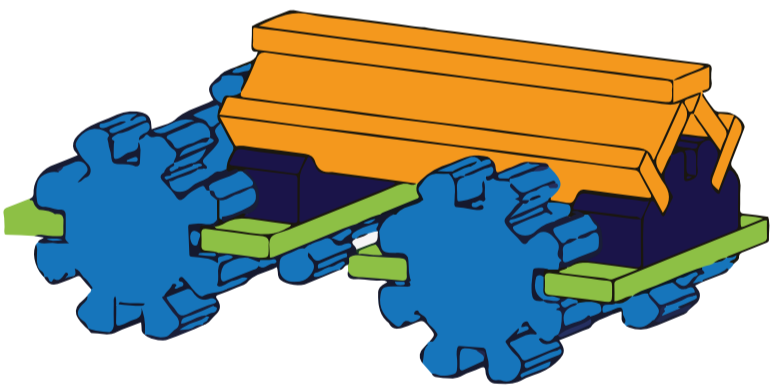

5 x4

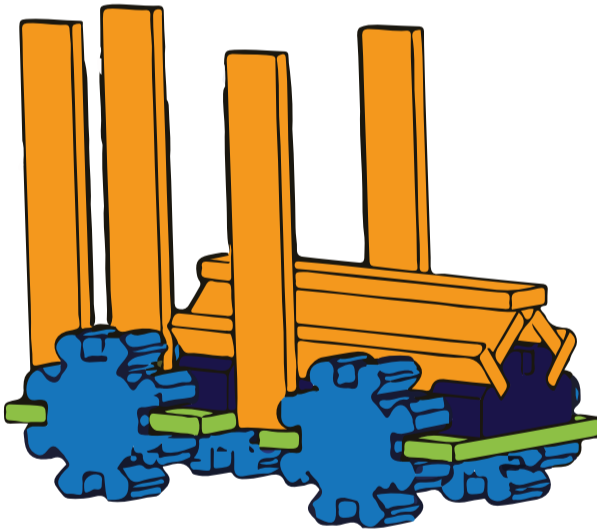

6 x2

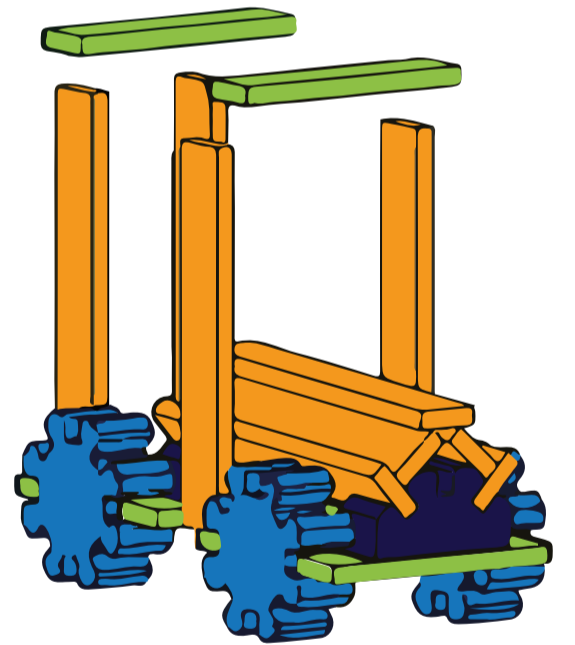

7 x4

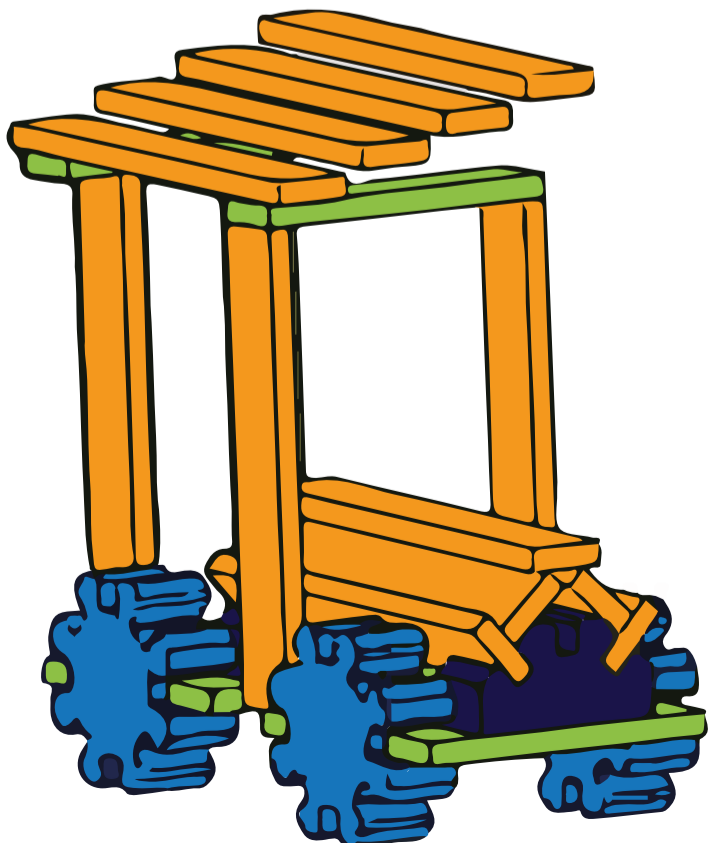

8 x1



1er Wagon

8  x2  x1

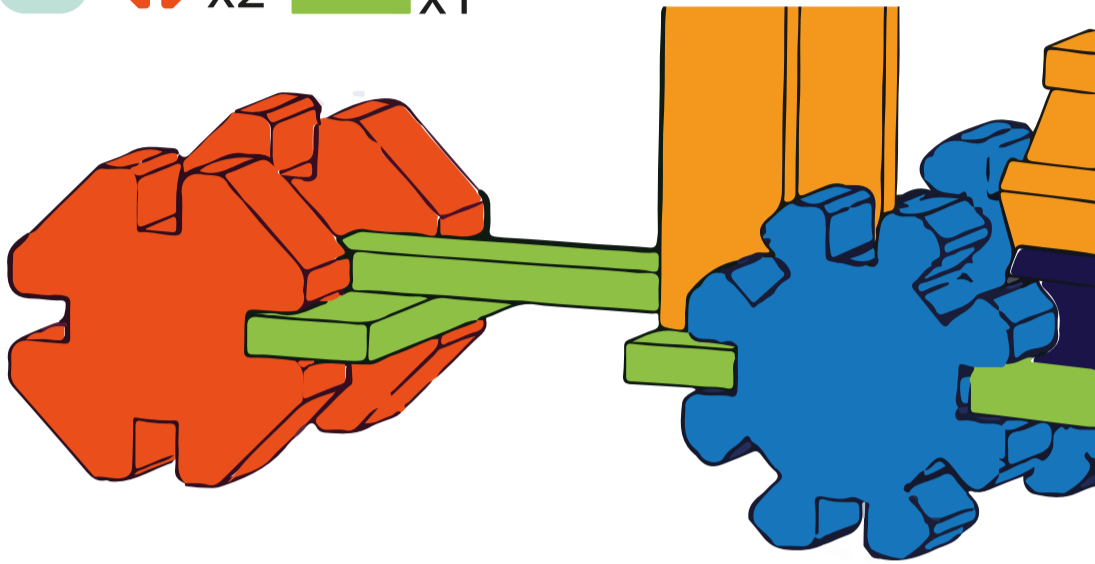

9  x2  x1

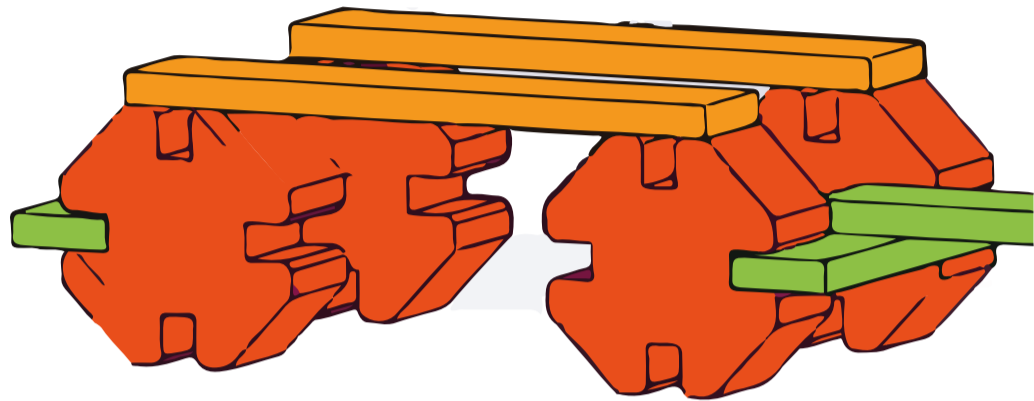

10  x6

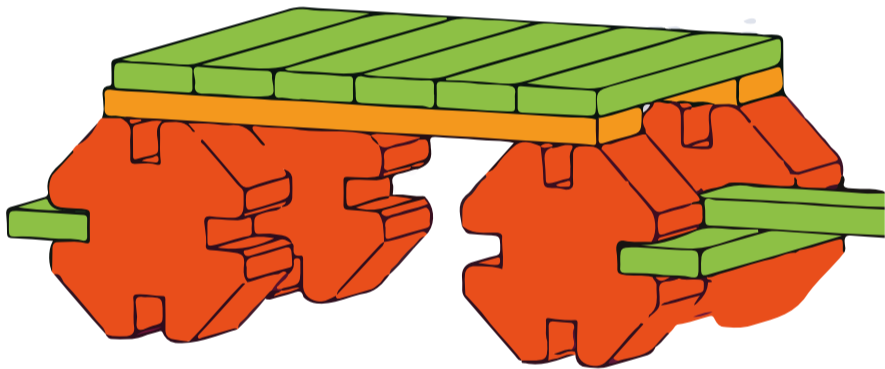

11  x6

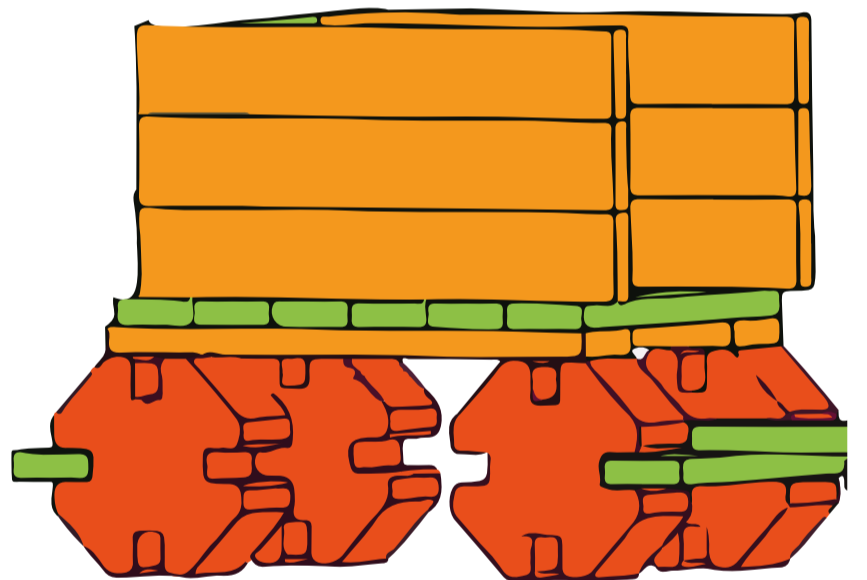

12  x4

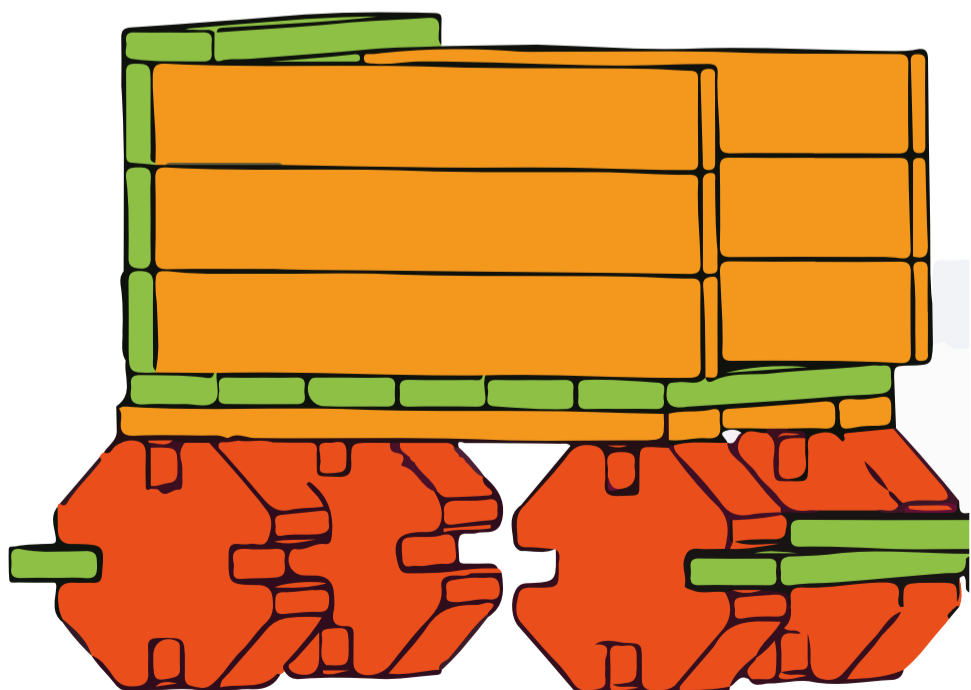

13  x1

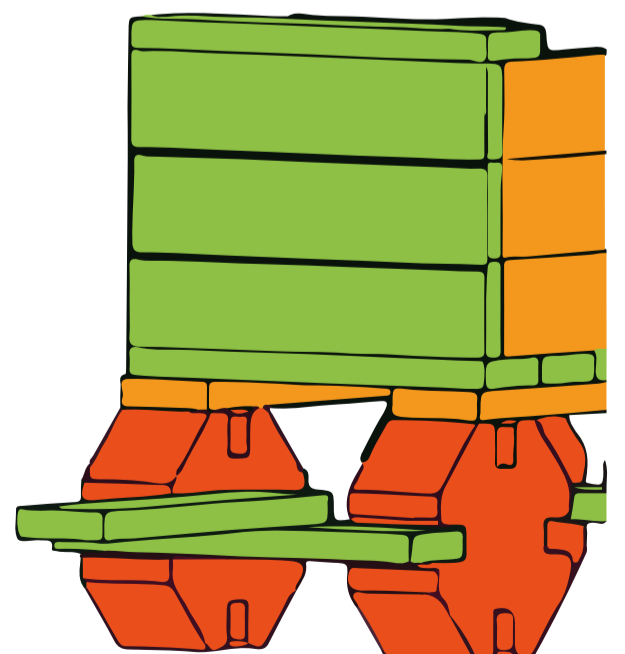

2ème Wagon

14  x2  x2

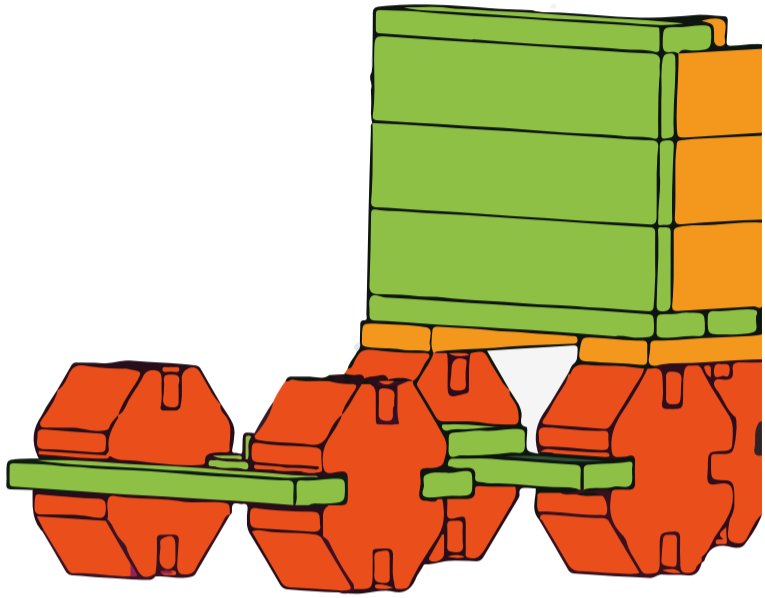

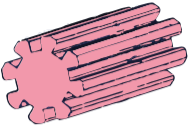
15  x1

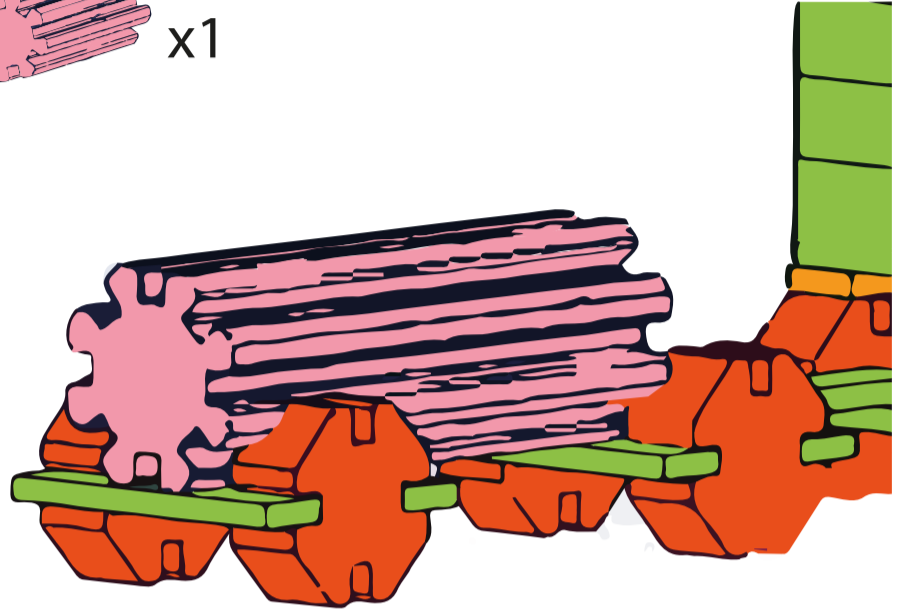

16  x1

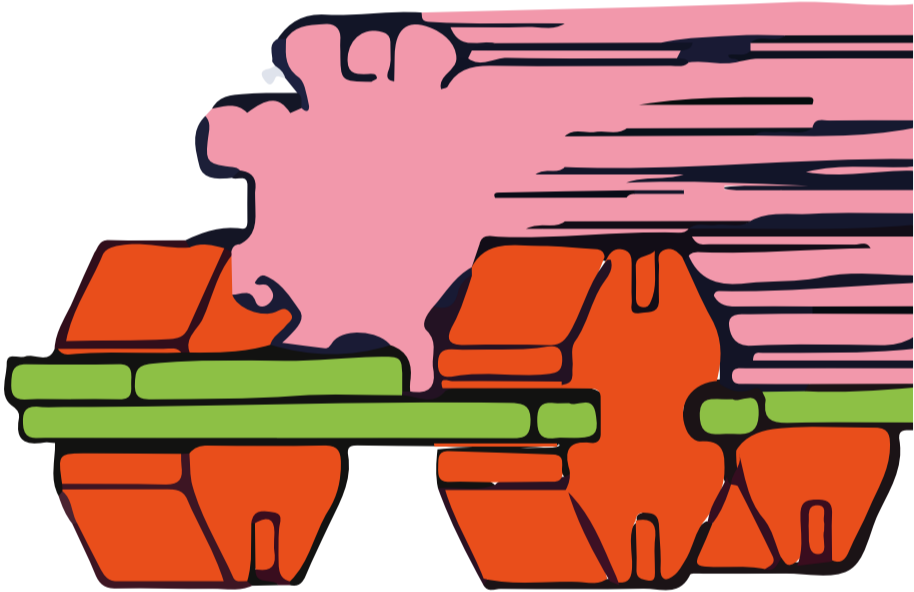

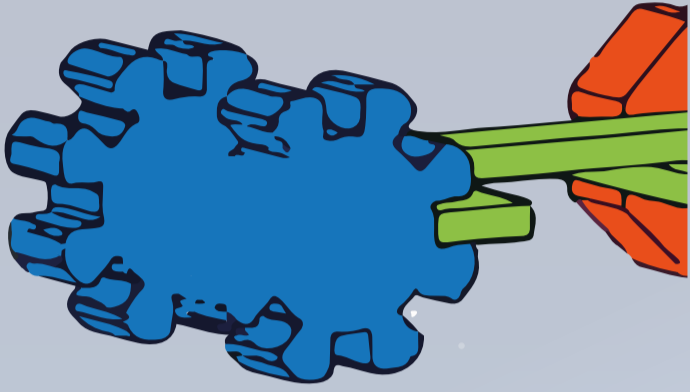

3ème Wagon

17  x2  x1

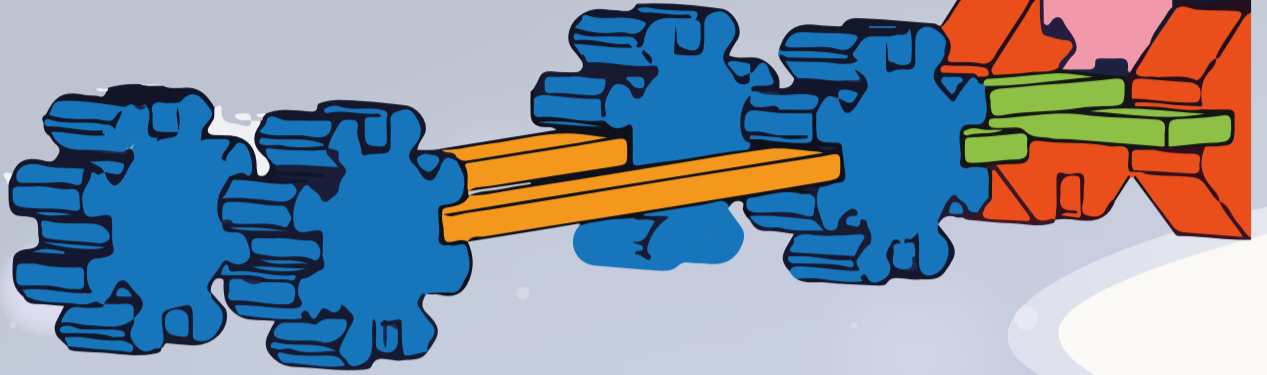

18  x2  x2



19  x5

